

IMSAB COMPONENT GUIDE for industry and shipping

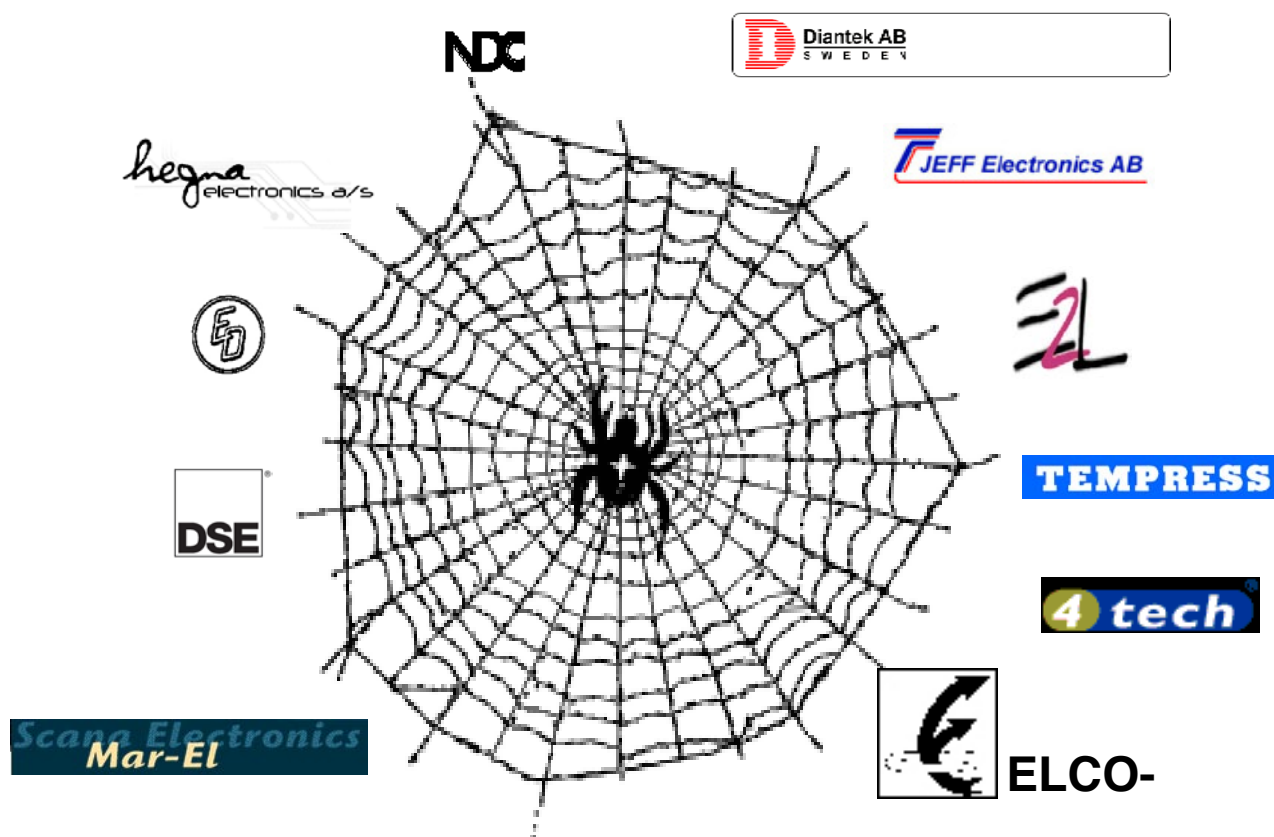

Operation alarm system LDC 10 LD 24V



ALARM DISPLAY SYSTEM LDC 10 LD

FOR USE IN MOST SURVEILLANCE SITUATIONS

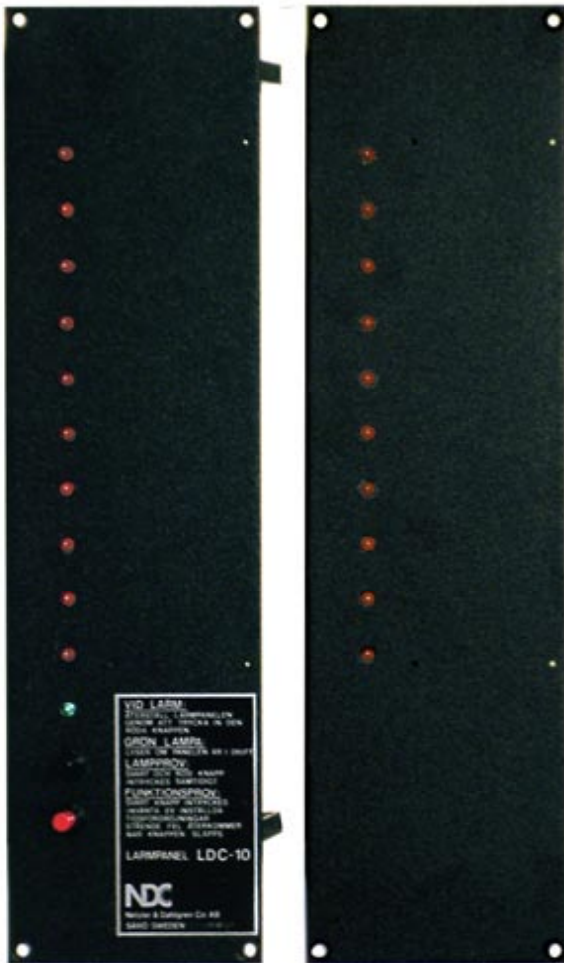

- Flashing light and memory
- Time delay on each channel
- Unique NDC group alarm test
- Running light indication
- Voltage failure indication
- Prepared for data transfer
- Certificated in CE-standards EN 50 082-2

ADVANTAGES AND OPERATION

LDC-10 is delivered programmed for use with normally open sensor contacts, but can easily be re-programmed, on site, for normally closed sensor contacts. All alarm channels have independent time delays.

LDC-10 can be fed from an AC supply. At the panel, the sensors indicator flashes when the pre-set time delay has elapsed. At the same time the output group to which it is connected, is activated. Alarms can be graded into three groups according to urgency. The alarm signal is **acknowledged with the red reset button**, and the corresponding lamp changes from a flashing to steady light, while at the same time the output contact for the alarm group is reset.

Functions test can be done with a push at the BLACK button, which simulate fault at the panel.

Lamp test can be done with a push at the button BLACK + RED button at same time.

The unit is also fitted with a special plug-in connector supplying extra information, such as alarm point status, to external units, for example, through an interface board (731) to a computer.

SECURITY

LDC-10 is designed for severe mechanical and electrical environmental conditions. It is provided with special protection against polarity reversal and accidental connection of voltage. The unit is designed to indicate voltage failures;

each group relay is normally activated. In the alarm state the relay is deactivated and a signal can be given, for example with a horn. The same thing happens when the supply voltage is interruption. All alarm channels are checked by the function test, including channels in alarm condition. When the black function test button is pressed, faults are simulated on all channels and all timers are started. Simulation of correction of existing alarms occurs during the time the button is held pressed in. The button is released after 30 seconds, when all timers have run out. The existing alarms are then activated and the corresponding timers start. After a further 30 seconds, all alarm channel have, therefore, been tested. None are left unchecked - a facility which is unique in alarm systems of this size.

LDC-10 is fitted with a running light indicator to confirm that the power is connected. Lamps are checked manually by pressing the black function test button and the red accept button, simultaneously. At the same time as the function test take place, a group alarm test is automatically made. This checks that all alarm channels are contributing to their group alarm output.

The unit is in accordance with CE-standards: EN 50 082-2; IEC 801-2:1991; ENV 50 140; ENV 50 141; IEC 801-4

INSTALLATION

LDC-10 is designed for panel-mounting. The unit is available in master and slave versions and the system can, therefore, be built up with one master and up to 9 slave units, giving a total of 100 alarm channels. The test and accept facilities are provided only on the master unit, which carries out these functions on behalf the slave units. The unit is connected through two easily accessible screw terminal blocks, each fitted with an additional terminal strip (plug and socket).

One of the terminal blocks is for connection of sensor leads and the second, for the other connections.

Connection is simple and the terminal arrangement allows the unit to be separated quickly, without disturbing the cable connections.

SPECIFICATIONS

Supply voltage: 24V or 48V AC/DC \pm 20%

Supply current: Normal condition 0,1

Alarm condition 0,2A

Time delay: Individually adjustable time 0,5-20 sec. each channel.



Output contacts: One change-over contact per alarm group (A - B - C alarms). Selection device on each alarm point contact rated max 100V 4A resistive load.

Front: Dull, black aluminium

Main dimension: 350x96x160 mm

Panel recess: 330x76 mm (19" 64x445mm)

Legends: Space for legends 50x15 mm

Max permissible external cable resistance: 5000 ohm.

Indicators: Red LED for unacknowledged alarm

12044
12045
12042
12043
12060
12061
12062
12063
Extra accessories:
731

ORDERING INSTRUCTIONS

LDC 10 M3R LD Master
LDC 10 S3R LD Slav
LDC 10 M3R LD 19" Master
LDC 10 S3R LD 19" Slav
LDC 10 M3R 48V LD Master
LDC 10 S3R 48V LD Slav
LDC 10 M3R 48V LD 19" Master
LDC 10 S3R 48V LD 19" Slav

Relay circuit board for an interface to computer or remote alarms.

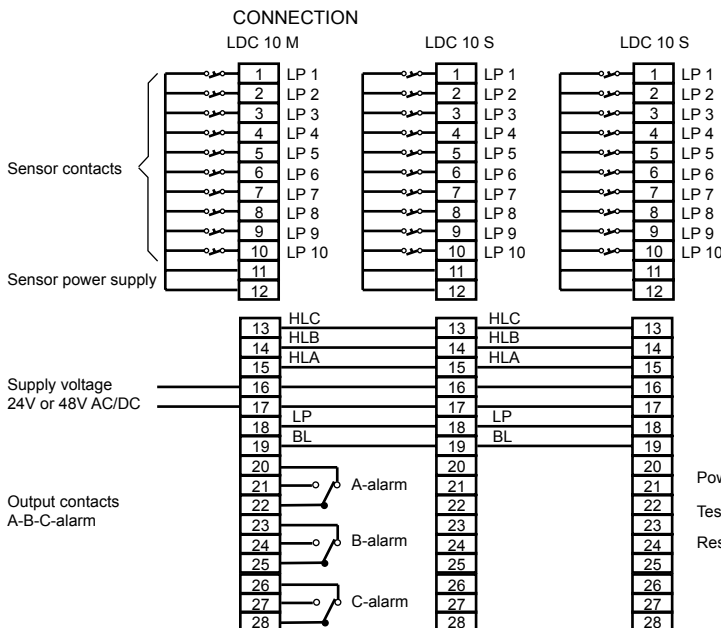
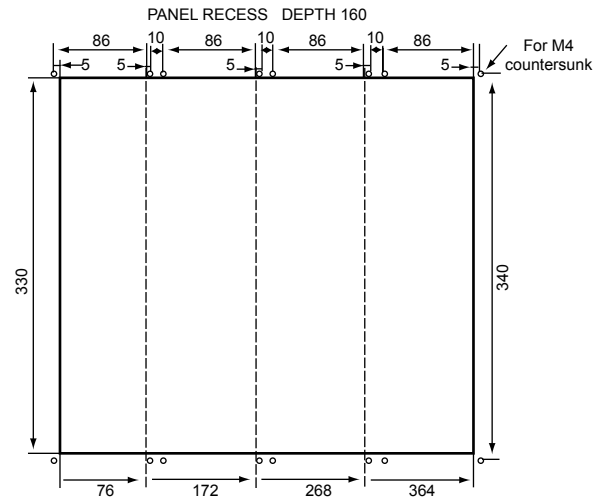
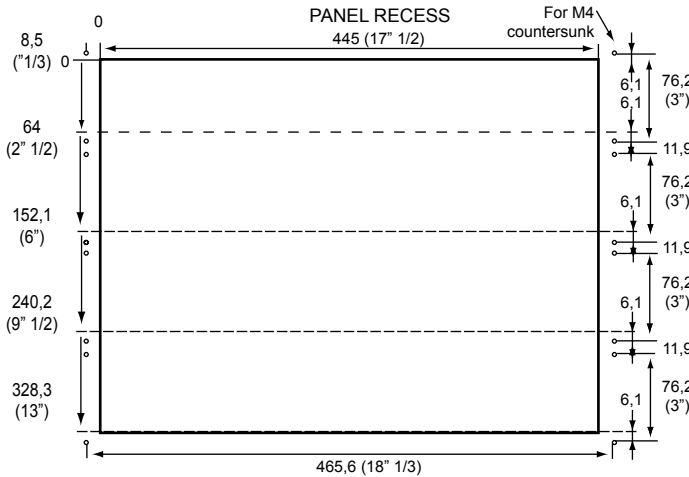
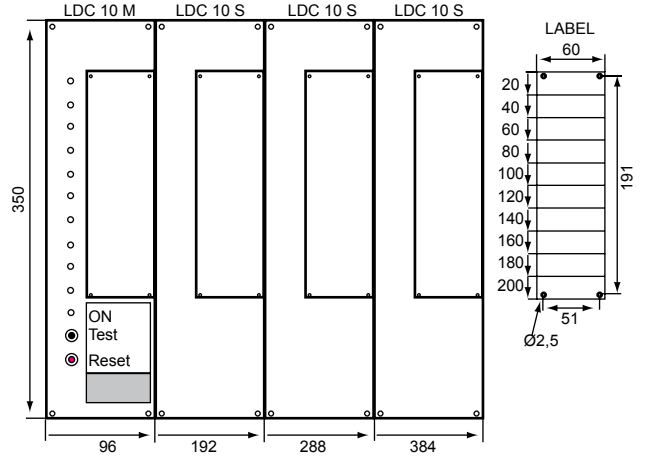
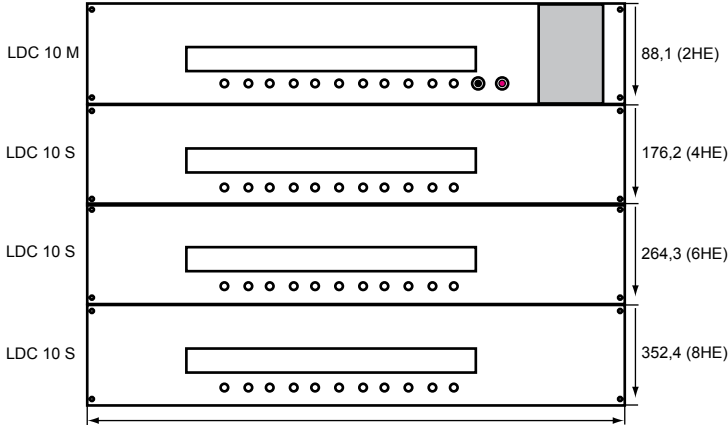

Note 1

When normally closed sensor contact (NC) is used this strap is to be cut.

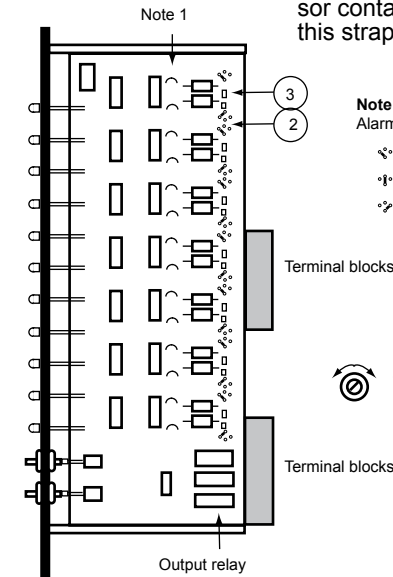

Note 2

Alarm group programming (strap)

- ◁ el. ∞ Group A
- el. ∞ Group B
- ▷ el. ∞ Group C

Note 3

Time delay adjustment

